



Conservatory Construction Company

(a division of Glass Enclosures Pty Ltd)

Australia's Leading Conservatory Specialist

1. *Company Profile*
2. *History of Conservatories*
3. *Benefits*
4. *Design Options*
5. *Material Options*
6. *Thermal Roof Blinds*
7. *Your Project*
8. *Gallery*
9. *Questions Answered*
10. *Contact Us*
11. *Printable Brochure*

Thank you

Thank you for taking time to read about our company. The Conservatory Construction Company has been manufacturing superbly engineered conservatories for over 25 years. We have built a reputation for integrity, taking pride in the manufacture and installation of the finest quality conservatories. Our standards are second to none.

On behalf of the management, designers and staff of Conservatory Construction Company - welcome to our company Website.





Company Profile

Since 1984 we have specialised in building Conservatories, becoming Australia's most experienced designers and builders in this high-tech area. We build contemporary and traditional conservatories, Australia wide.

We employ highly trained tradesmen on each project, which has been specifically tailored to your unique requirements. Our own installation team will install your conservatory with minimum disruption to you or your family.

We pride ourselves on customer care and quality, our fully trained staff all dedicated to providing fine quality craftsmanship and a first class conservatory from start to finish.

Our philosophy of excellence in design, workmanship and service is the foundation of our company. The results are the embodiment of our clients' desires. Each conservatory has its own character, whether it is a traditional timber frame design or maintenance-free aluminium, our attention to detail is obvious in the completed project.

Our reputation for innovation and adaptability has presented us with many challenges over the years. We welcome these challenges enjoying the end result as much as our satisfied customers.

Portfolio.

Our portfolio of work is extensive. We have constructed many beautiful conservatories, from small meals-area conservatories on modest homes, to large traditional conservatories on grand Victorian mansions. Our designers have years of experience with a wealth of knowledge which brings interesting and attractive solutions no matter how "difficult" the site.

Confidence in our Product.



From start to finish, we take the time and care to provide you with an all inclusive, trouble free package. This covers advice, design, estimating, planning and building applications, foundations, manufacture, and installation to meet all building, glazing & planning regulations.

Just as important in your choice of design & product is the importance of the guarantees and back up services.

As licensed building practitioners, we adhere to a strict code of practice, taking particular care to adhere to all building, planning and local authority regulations.

All our projects are covered by builders', public liability and housing indemnity insurances, giving clients complete peace of mind.



History

Conservatories, when first designed in the 17th century, were intended to conserve exotic plant species in northern European climates. The earliest buildings were used simply to keep the frost from plants so that they would survive the winter until they could be grown again outdoors in spring.



The fantastic ambience soon saw them move into an elegant link between the house and garden, they were often a grand affair, built with a classical style, many incorporating stone columns, tall, semi-circular sash windows and positioned to enable imposing views over the surrounding estate parklands or rural countryside.

The interiors had stone floors, and in the summer months were furnished with a large grand table and chairs to provide a beautiful setting for meals and entertaining.

Because of modern manufacturing techniques, conservatories are now a versatile, affordable, and easy way to increase living space and add beauty and charm to any style of home.

Conservatories Today

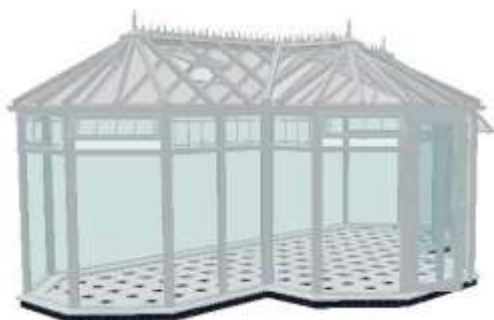

Conservatories have come a long way in the last 25 years. Modern manufacturing methods and materials coupled with traditional craftsmanship and computer-aided design, ensure we give our clients greater choice of materials and more design alternatives.

The Conservatory Construction Company's conservatories are based on a unique concept, designed as an integral conservatory building system and not just a collection of windows and doors. Our aluminium or timber

conservatories are carefully manufactured using traditional joinery methods with the aid of modern technology and machinery.

Whether you desire a sunny space to sit back and relax, a home office, a comfortable room to entertain family and friends, or enjoy a romantic candlelight dinner, our conservatories will add a serene extra dimension to your life

The options available make the conservatory of today the most exciting way of enhancing your home and lifestyle. Options include types of frame construction, different glazing systems and glass types, hi-tech motorised or manual thermal roof blinds and roof-opening systems.

Our numerous design options fit your lifestyle needs; breakfast nook, family room, dining room or den, bedroom or studio, hot tub spa, music or family room... anything you wish it to be,

...it's not just a room, it's a lifestyle...



Benefits

The real joy of being in this very specialised area of the design and construction industry is returning to visit our owners after the conservatory is completed. Invariably they will say something like:

"We love our conservatory ... it's so relaxing ... we spend more time in this room than any other ... I don't know why we have the rest of the house."



Conservatories are not acquired simply as room additions but as enhancements to lifestyle. Our clients are often seeking an escape from the pressures of every day life; they find the conservatory, a space filled with light and surrounded by garden, a soothing reward for their hard work.

The real beauty of a conservatory is that it is a room, which is part home, part garden. On a summer's day with the doors open and the heady smell of flowers in the air, the conservatory is simply an extension of the garden. On less clement days it is a cosy and comfortable haven in which to enjoy the outdoors whilst the wind and rain are firmly excluded.

Uses



Our conservatories are designed for a variety of budgets and tastes. You can choose from a variety of materials, finishes and glazing options that complement any style of home, the conservatory's glass roof allowing you to add on to a dwelling without losing light to existing rooms.

Conservatories are used as family rooms, dining rooms, kitchen extensions, pool and spa enclosures and porches. Conservatories are designed to enhance our homes and lifestyles ... the room we gravitate to ... to relax in ... to bring the outdoors in year-round.

Add extra living space, which significantly increases the value of your home, improving your lifestyle no matter what the weather brings. It's a place to dine in, entertain friends or just simply relax. Ideal for family get-togethers, all-weather entertaining, private study or just quiet relaxation and contemplation any time of the year, day or night.

Spring, summer, autumn or winter, you can enjoy a conservatory by the Conservatory Construction Company all year round.

Summary

With the rediscovery of the conservatory now transformed by modern technology, this delightful and practical way of adding light, relaxed atmosphere and style in glass, offers unlimited possibilities for additions, extensions or renovating.

The conservatory is now firmly re-established as the only design response, for new or existing homes, romantically and practically bridging the gap between indoors and outdoors, an impossibility using traditional methods of construction.





Design Options

Range

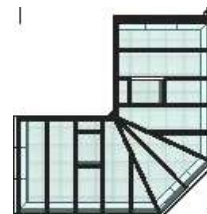
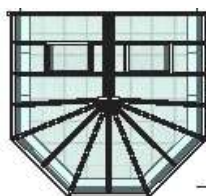

The shape and design of your conservatory is limited only by your imagination....

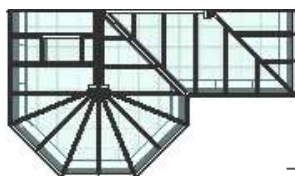
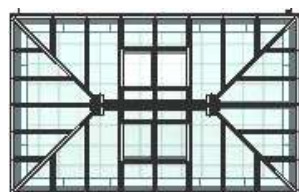

Building a conservatory goes far beyond creating extra space. A conservatory can add character and light to the entire house. Our conservatories are designed and built to meet the individual requirements and taste of each client. They can be designed to suit all styles of properties, from modern to Georgian, country cottages to Victorian town houses.

Choose from traditional designs, with all the nostalgia, charm and opulence of a more gracious era, or the style, clean lines and elegance of contemporary glass construction.

What's Best for my Home?

Choosing the conservatory that's right for your home is extremely important; that's where getting the correct advice comes in. At the Conservatory Construction Company we believe in personal service - spending the time necessary to become familiar with your requirements and your home, so that the correct advice can be given and the best design achieved.



Attention to detail, innovation and adaptability, are the hallmarks of our experienced designers. They will assist you in choosing from traditional or contemporary styles, the types of materials best suited, right down to the type of door handles and the most suitable furniture.

Experience is essential in areas such as achieving the right feel - getting the correct amount and type of ventilation and lighting - whether thermal roof blinds will be required, and dealing with the more hi-tech aspects such as automatic roof openings etc. We enjoy working closely with our clients to achieve their desired results.



Design

Our traditionally designed conservatories are particularly well suited to older style homes, or reproduction older style. Typically we would include such features as:



- bay fronts
- porticos
- etched or stained glass
- curved, gothic, federation or colonial window and door panels
- roof lanterns (raised section running length of ridge)
- ridge cresting and finials (from traditional moulds)

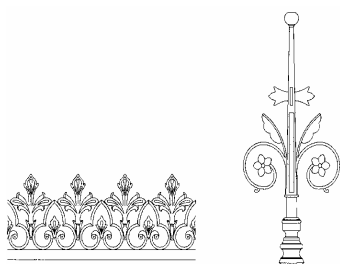

Our more modern designs on the other hand, are suited to a far broader range of residences. Because we often include traditional elements, they are suited to all homes from 1930's and 40's right up to brand new architecturally-designed inner city townhouses, with many beautiful conservatories having been constructed on what might be termed "average suburban homes".

Working with you.

If you have an idea in mind, we can take that idea to reality and we are there to help with suggestions if and when you need them. Our systems are so versatile that conservatories can be built to virtually any size. After all, your home is unique, so your conservatory should be too.

However you wish to use your conservatory, we'll make sure it's the right one for your needs, your budget and the style of your property.

Materials - Options

Individually Designed

The challenge of taking something from a client's imagination, interpreting that vision and then transforming it to reality is one of the most satisfying aspects of our business.

Because all our projects are individually designed, we work with a large range of materials to be able to satisfy the design demands of each project.



Choices

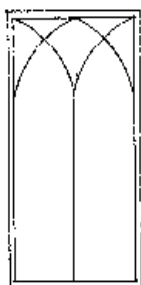

Typically the main structure would be constructed from timber, aluminium or steel, or a combination of these, taking into consideration overall design, structural requirements, maintenance etc.

Over 20 years building conservatories has taught us that there is no substitute for glass as a roof and window material. This fantastic product often taken for granted is unaffected by U.V., does not deteriorate in the weather requires no maintenance other than an occasional clean and using modern technology such as toughening or laminating is extremely strong, providing a high level of safety and security.



Options

These may include

- Powder-coated aluminium for freedom from maintenance
- Hardwood or cedar timber
- Casement, awning, double hung or sliding windows for ventilation
- French, bi-fold and sliding doors
- Lead-light, frosted or coloured glass
- Personalised locking and security and glazing systems for maximum security
- Insect screens
- Tiled or timber flooring
- Brick or stonework

Hi-tech Options

Common options include

- Double glazing, high performance or Low E glass
- Opening roof windows, manual or motorised
- Thermal roof blinds, manual or motorised
- In-slab heating
- Extending existing heating and cooling systems

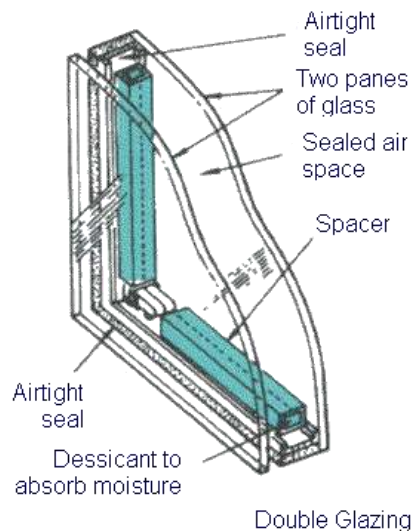



Thermal Roof Blinds

Are they required?



Many prospective clients express concern about excessive heat gain in summer, and possible heat loss in winter. While this is a valid concern, it is not a problem when the conservatory has been designed by an experienced conservatory designer i.e. with correct ventilation, glazing etc. However, to give our clients the ultimate in light and temperature control, we manufacture and install thermal glass roof blinds, basically allowing you to protect the conservatory from too much sun on those very hot days, and preventing heat loss on a cold winter's night.

Performance

Thermal blinds reflect the sun's rays in summer and retain the heat in winter, making them an ideal option for any conservatory.

The fabric used in our blinds is the key to the above high performance characteristics. It is a combination of polyester impregnated with fungicide, laminated with a highly reflective film and backed with a polymer coating (technology originally designed by the N.A.S.A. space programme). This gives the blinds their special qualities and ensures they are extremely strong, lightweight, lightfast, long-lasting and easy to clean.



Another major benefit of this outstanding fabric is the ability to make blinds for all irregular shapes and have all the blinds re-tractable. Conservatories and glass roofs come in a large range of sizes and shapes and we are renowned for our ability to design blinds that fit the most awkward shapes and roof angles. Blinds can even be designed to fit over opening roof windows.

An essential element is the installation, as expert fitting combined with the extremely light weight of the fabric means beautiful clean lines.

Operation

The Conservatory Construction Company's thermal blinds can be operated manually and, for the ultimate in temperature and light control, there are motorised electronic systems. These systems can be operated by a discreet wall-mounted switch, by remote control or thermostat.





Your Project

Our approach



The Conservatory Construction Company handles the whole project for you from site survey and design to pouring foundations and installation, all of which is undertaken by our own staff and installers.

Our initial site survey and quotation service is completely free of charge. An experienced consultant will guide you through the aspects of design and the many options to suit your individual project and a detailed quotation is provided.

Once you decide to proceed, detailed working drawings and specifications are generated and submitted for planning and building permits, all under our supervision. We have much experience with listed buildings and heritage overlay areas.

Once you decide to proceed, detailed working drawings and specifications are generated and

“Conscientious and professional” summarises the Conservatory Construction Company's package. Every installation is carried out with the utmost care and attention. We appreciate that your home is your pride and joy and we will treat it with respect. We cover and protect all vulnerable surfaces and go to great lengths to minimise disturbance to you and your family.



Once the installation is complete our contracts manager will carry out a final inspection and check that you are completely satisfied with the product and installation.

Because of our experience in this highly specialised form of construction we are happy to assist our clients with design advice in any associated areas, for example kitchens, pools, exterior lighting etc. If there is any aspect of the project that you wish to arrange e.g. using your own electrician, pool company etc., we are very happy to work in with your arrangements, just mention it to our designer.

Guarantees and insurances.



As registered building practitioners all building code, planning and local government regulations are strictly adhered to, with all our constructions having full structural calculations carried out by qualified engineers.

To give you full peace of mind, all work on your property is covered by our public liability insurance, full builders on site insurance and housing indemnity insurance.

All work and materials are guaranteed for 6 years. After Sales service is at your request always! Should you have any reason to call, one of our staff will promptly come to inspect and arrange any work that may be necessary.



Our code of ethics:

1. Provide products and services with competence, fairness, value, honesty and integrity;
2. Ensure that all products and services provided are delivered as advertised, and that all claims made are genuine;
3. Ensure that standards of workmanship are provided as promised to the customer, in accordance with the appropriate industry practice for the class of work concerned, and in a manner which shall enhance the reputation of the industry;
4. At all times conduct their business in free and fair competition, and refrain from making any misleading or untrue statements

Company Philosophy

Our philosophy of excellence in design, workmanship and service is the foundation of our company. With our stringent Quality Control procedures and modern materials you can rest assured that every conservatory will be strongly made for a lifetime of comfort and enjoyment.



The results are the embodiment of our clients' desires. Each conservatory has its own character whether it is a timber frame design or maintenance free aluminium or steel; our attention to detail is manifest in the completed project.

Our reputation for innovation and adaptability has presented us with many challenges. We, the Conservatory Construction Company, welcome these challenges enjoying the end result as much as our satisfied clients.



GALLERY

Project 1: A Traditional conservatory



The customer's brief

To design and construct a conservatory on the rear wall in keeping with the elegance of the existing dwelling giving extra space and enhanced views to the garden and pool.

Our solution

The relatively plain existing two-storied rear wall gave our designers an opportunity to design a traditional bay fronted style conservatory with elaborate mouldings. Continuing the glass roof to form a verandah meant conformity of design and extra light to the adjacent kitchen. The result, a light restful area allowing a full appreciation of the garden and pool.



Project 2 : A beautifully light kitchen addition

The customer's brief

The owners of this beautiful two storey terrace wished to extend their small kitchen / meals area. The problems being very little space available to the boundary and concern about loss of light.

Our solution.

To remove totally the existing wall and extend to the side boundary with glass roof and doors to face the rear courtyard. The laying of a beautiful timber floor throughout the existing kitchen/meals area and into the small conservatory addition has resulted in a beautiful light living space that has brought this area up to the high standard of the rest of the home.





Project 3 : A Country Property

The customer's brief



Perfectly sited overlooking a bushy valley, this home's formal dining area was dark, too small and did not take advantage of the fabulous views.



Our solution

By removing the external wall and verandah we were able to build a glass roofed conservatory with bay front and gothic embellishments which gave extra space, took in the wonderful views and created a stunning light filled dining area. Carpet with contrasting border, a chandelier and beautiful dining table added the icing to the cake.

Project 4 : Grandeur on an existing deck

The customer's brief:



To utilise an infrequently used concrete deck area above the residents kitchen, incorporating additional bedroom space and separate dining / entertaining area.

Our solution

Because of the large area involved a twin ridge roof structure with central box gutter was designed which mimicked the contours of the existing house. The unique style and superb detailing within this large Heritage home meant extra detailing to the conservatory, including extremely ornate solid bottom panels to wall areas and internal mouldings to rafters and head beams. The result was a beautifully integrated conservatory which added a new dimension to an already impressive home.

Note the use of Thermal Roof Blinds in the Conservatory to the right..





Project 5 : An outdoor patio transformed.

The customer's brief:

To infill a rarely used outdoor patio area, and to form a covered link between the garage and house. Also important was to incorporate an extended dining area off the kitchen.



Our solution :

Working as a tight unit in conjunction with the owner, a prominent interior designer, we ticked every box in the criteria. Double pitch roofs were designed,

sloping into a central box gutter, which enabled us to extend the roof area and conservatory over to the garage, whilst maximising the patio area to its full potential. Marble floor tiles were fitted in conjunction with under-floor heating to ensure the right ambient temperature during the winter months. Large Bi-fold doors were incorporated along the whole front elevation, which when opened fully during the warmer days, enabled a seamless transition between the garden and conservatory.



Project 6 : Rear area makeover

The customer's brief:

To give additional space to a small kitchen and dining area and to form a relaxing retreat



Our solution :

A rear passage linking the kitchen to a laundry was removed together with a brick chimney. The conservatory was then built into the newly created area. The wall between the kitchen and conservatory was removed which opened up the whole area enabling a large

sitting/lounge area to be formed.

The conservatory was designed & embellished to match the Heritage weatherboard cottage, resulting in an elegant, traditional addition whilst adding much needed living space.





Project 7 : Light casual living

The customer's brief:

This brick veneered 1980's family home had very little informal living space, so our client required the addition of a living area close to the kitchen that was light, gave good views of the garden whilst not reducing light to the adjoining kitchen & dining areas.



Our Solution

Large openings were formed into the kitchen / dining rooms with the large conservatory constructed in the 'L' formed by these two rooms. The conservatory glass roof was blended into the existing tile roof with the addition of a tiled gable.

Minimal embellishments allowed its clean lines to match those of the existing home. The new conservatory has added light, space and a large amount of extra casual living and entertaining space. It also adds balance to the living, formal and bedroom areas, greatly enhancing the lifestyle of all members of the large family, a great result!





Frequently Asked Questions

What are conservatories used for:

Anything you wish. Predominantly used as a quiet retreat from the rest of the house, our conservatories have also been used for kitchen extensions, lounge / dining rooms, rumpus rooms, home office areas, art studios, home gymnasiums, and commercially as restaurants, retirement homes, relaxation areas, spa / swimming pool enclosures... the list is endless. With the use of glass, conservatories are a multi-functional room. Many of our past clients regularly remark on how often they use it compared to the rest of the house and how it has changed their lifestyle.

What Is The General Construction:

Because all our projects are individually designed, we work with a large range of materials to be able to satisfy the design demands of each project. Typically the main structure would be constructed from timber, aluminium or steel, or a combination of these, taking into consideration overall design, structural requirements, maintenance etc.

Which Best Suits My Property:

Choosing the conservatory that's right for your home is extremely important; that's where getting the correct advice comes in. At the Conservatory Construction Company we believe in personal service – spending the time necessary to become familiar with your requirements and your home, so that the correct advice can be given and the best design achieved.

How Do You Combat Heat In Summer / Cold In Winter:

Many prospective clients express concern about possible excessive heat-gain in summer, and possible heat-loss in winter. Whilst this is a valid concern, it is not a problem when the conservatory has been designed by an experienced conservatory designer i.e. with correct ventilation, glazing etc. However, to give our clients the ultimate in light and temperature control, we manufacture and install thermal glass roof blinds, basically allowing you to protect the conservatory from too much sun on those very hot days, and preventing heat-loss on a cold winter's night.

Would I Need Double Glazing

Not always. Single glazing is adequate for the majority of situations. However if heat loss in winter is anticipated to be of concern, then double glazing is recommended. Our experienced designers will be able to offer more advice in the early stages of discussion.

What About Building / Planning Permits

The majority of the time you won't require planning permits but every construction / addition to your home will probably require a building permit. Our team of designers and draughtsmen carry out all work to gain any permits required 'in house', thus eliminating the need for costly consultants.

How Do I Keep The Structure And Roof Clean

Depending on the surrounding area, glass roofs, like iron roofs are to a large degree self cleaning. If necessary the glass roof area and walls are easily cleaned down using a hose and soft brush. We also provide specialist window cleaners who will clean the roof area at very little cost. We have conservatories which are many years old that have never had the need to have the roof cleaned.



Do you work in conjunction with builders and Architects.

Yes. We will be very pleased to work alongside your nominated builder or Architect. It would be beneficial for all parties to involve us at the initial design stage, so we could offer our 20 years experience and specialist knowledge regarding the construction, design, ventilation and any other aspect relative to your conservatory.

Contact Information

"We come to you"

Email: conservatoryco@msn.com

Melbourne contact details:

The Conservatory Construction Company,

Tel. (03) 9866 8240

Adelaide contact details:

The Conservatory Construction Company,

Tel. (08) 8271 7960